

HC 60 K

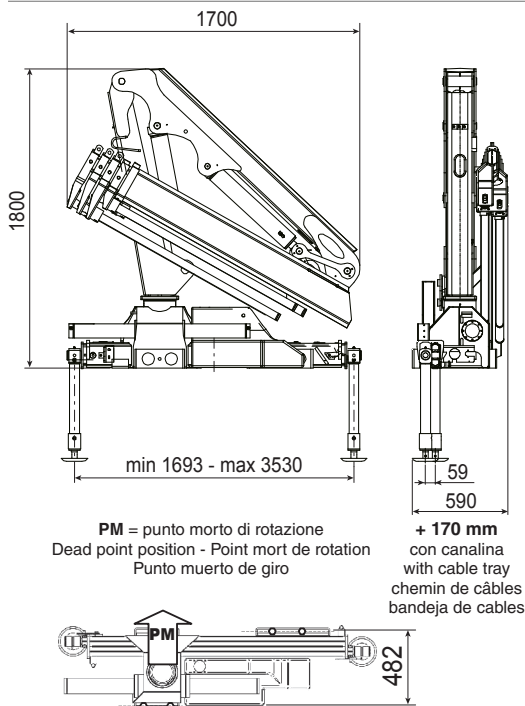

I MIGLIORI PRODOTTI DI QUALITÀ | BEST QUALITY PRODUCTS

www.hcindustrie.com



GRU STANDARD Std Crane - Grue Standard - Grua standard

Bracci stabilizzatori standard Std outrigger booms - Bras de stabilisation std. - Brazos estabilizadores std.	mm. 3530
Angolo di rotazione Slewing angle - Angle de rotation - Giro	365°
Tiranti di ancoraggio (kg. 20) Tie rods for anchorage - Tirants d'ancrage - Tirantes de fijación	n°8 Ø20x1,5 mat. 39 Ni Cr Mo3
Portata raccomandata Recommended oil flow - Débit recommandé - Caudal requerido	l/min. 15
Capacità del serbatoio Tank capacity - Capacité du réservoir - Capacidad del depósito de aceite	lt. 24
Pressione massima Rated pressure - Pression maxi - Presión máxima	bar 270

HC 60 K A2

Massa della gru senza olio nel serbatoio
Overhang crane without oil in the tank - Poids de la grue sans huile dans le réservoir - Peso de la grua sin aceite en el depósito **Kg. 615**

Momento di sollevamento massimo
Maximum lifting moment - Moment de levage maxi - Momento de elevación máxima **tm 5,2**

Sbraccio oleodinamico
Maximum hydraulic reach - Déport hydraulique - Alcance hidráulico

Orizzontale Horizontal - Horizontal - Horizontal **m. 5,61**
Verticale Vertical - Vertical - Vertical **m. 8,41**

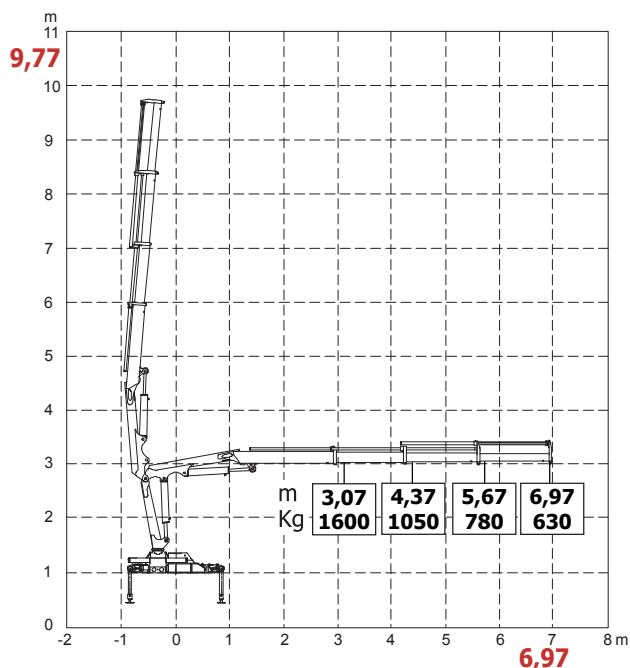
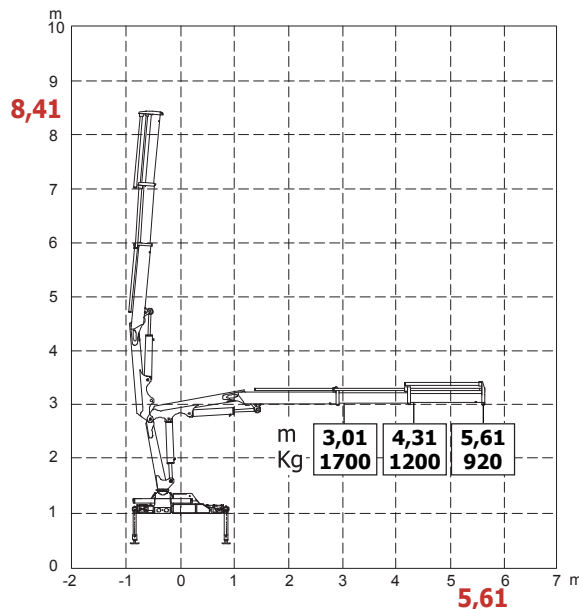

HC 60 K A3

Massa della gru senza olio nel serbatoio
Overhang crane without oil in the tank - Poids de la grue sans huile dans le réservoir - Peso de la grua sin aceite en el depósito **Kg. 660**

Momento di sollevamento massimo
Maximum lifting moment - Moment de levage maxi - Momento de elevación máxima **tm 4,9**

Sbraccio oleodinamico
Maximum hydraulic reach - Déport hydraulique - Alcance hidráulico

Orizzontale Horizontal - Horizontal - Horizontal **m. 6,97**
Verticale Vertical - Vertical - Vertical **m. 9,77**

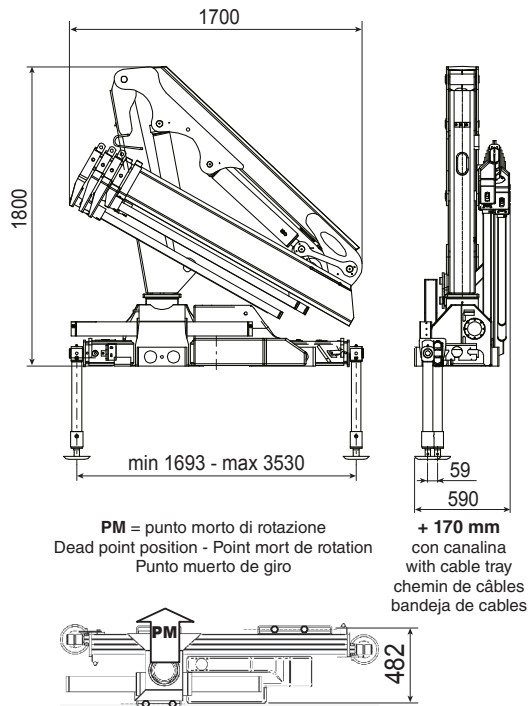

GRU STANDARD Std Crane - Grue Standard - Grua standard

Bracci stabilizzatori standard Std outrigger booms - Bras de stabilisation std. - Brazos estabilizadores std.	mm. 3530
Angolo di rotazione Slewing angle - Angle de rotation - Giro	365 °
Tiranti di ancoraggio (kg. 20) Tie rods for anchorage - Tirants d'ancrage - Tirantes de fijación	n°8 Ø20x1,5 mat. 39 Ni Cr Mo3
Portata raccomandata Recommended oil flow - Débit recommandé - Caudal requerido	l/min. 15
Capacità del serbatoio Tank capacity - Capacité du réservoir - Capacidad del depósito de aceite	lt. 24
Pressione massima Rated pressure - Pression maxi - Presión máxima	bar 270

HC 60 K A4

Massa della gru senza olio nel serbatoio
Overhang crane without oil in the tank - Poids de la grue sans huile dans le réservoir - Peso de la grua sin aceite en el depósito **Kg. 700**

Momento di sollevamento massimo
Maximum lifting moment - Moment de levage maxi - Momento de elevación máxima **tm 4,76**

Sbraccio oleodinamico
Maximum hydraulic reach - Déport hydraulique - Alcance hidráulico

Orizzontale Horizontal - Horizontal - Horizontal **m. 8,33**
Verticale Vertical - Vertical - Vertical **m. 11,13**

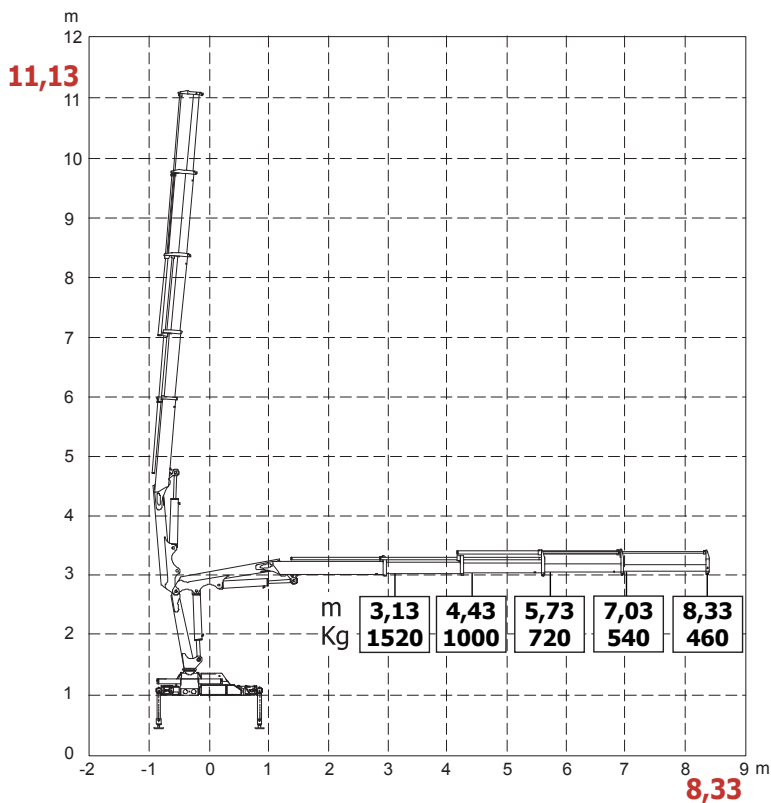



TUTTI I DATI TECNICI POSSONO ESSERE CAMBIATI SENZA PREAVVISO - ALL TECHNICAL DATA CAN BE CHANGED WITHOUT NOTICE
TOUS LES DONNEES TECHNIQUES PEUVENT ETRE MODIFIEES SANS PREAVIS - TODOS LOS DATOS TECNICOS PUEDEN SER CAMBIADOS SIN AVISO

HC INDUSTRIE S.R.L.

Via Luciano Romagnoli, 1

42023 Cadelbosco di Sopra Reggio Emilia, Z.I. La Madonnina (RE)

Phone +39.0522.911729 - Fax +39.0522.404040

Email: commerciale@hcindustrie.com - Website: www.hcindustrie.com